



FLECK 5600SXT DOWNFLOW
SERVICE MANUAL



TABLE OF CONTENTS

JOB SPECIFICATION SHEET	2
INSTALLATION.....	3
START-UP INSTRUCTIONS/FLUSHING & CONDITIONING	4
CONTROL FEATURES.....	4
TIMER OPERATION	5
USER PROGRAMMING.....	6
MASTER PROGRAMMING MODE CHART	7
MASTER PROGRAMMING MODE.....	8
USER PROGRAMMING MODE.....	11
DIAGNOSTIC PROGRAMMING MODE.....	11
56SXT SOFTENER METER.....	13
56SXT SOFTENER TIME CLOCK.....	13
56SXT BACKWASH FILTER TIME CLOCK.....	13
56SXT VALVE ACCESSORIES.....	14
56SXT VALVE ASSEMBLIES.....	15
CONTROL VALVE ASSEMBLY	16
VALVE POWERHEAD ASSEMBLY	18
3/4-INCH TURBINE METER ASSEMBLY	19
3/4-INCH PLASTIC PADDLE METER ASSEMBLY	19
BYPASS VALVE ASSEMBLY (PLASTIC).....	20
BYPASS VALVE ASSEMBLY (METAL)	21
2300 SAFETY BRINE VALVE	22
2310 SAFETY BRINE VALVE	23
TROUBLESHOOTING.....	24
WATER CONDITIONER FLOW DIAGRAMS.....	26
WIRING DIAGRAM.....	27
SERVICE INSTRUCTIONS	28
FLOW DATA & INJECTOR DRAW RATES	30

JOB SPECIFICATION SHEET

Job Number: _____
Model Number: _____
Water Hardness: _____ ppm or gpg
Capacity Per Unit: _____
Mineral Tank Size: _____ Diameter: _____ Height: _____
Salt Setting per Regeneration: _____

1. Type of Timer:

- A. Time Clock
- B. Meter Initiated

2. Downflow: Upflow Upflow Variable

3. Meter Size:

- A. 3/4-inch Turbine
- B. 3/4-inch Paddle Wheel
- C. Electronic ____ Pulse Count ____ Meter Size _____

4. System Type:

- A. System #4: 1 Tank, 1 Meter, Immediate, or Delayed Regeneration
- B. System #4: Time Clock

5. Timer Program Settings:

- A. Backwash: _____ Minutes
- B. Brine and Slow Rinse: _____ Minutes
- C. Rapid Rinse: _____ Minutes
- D. Brine Tank Refill: _____ Minutes
- E. Pause Time: _____ Minutes
- F. Second Backwash: _____ Minutes

6. Drain Line Flow Control: gpm

7. Brine Line Flow Controller: gpm

8. Injector Size#:

CALIFORNIA PROPOSITION 65 WARNING

⚠ WARNING: This product contains chemicals known to the State of California to cause cancer or birth defects or other reproductive harm.

INSTALLATION

Water Pressure

A minimum of 20 psi (1.4 bar) of water pressure is required for the regeneration valve to operate effectively.

Electrical Facilities

An uninterrupted alternating current (120 VAC) supply is required. The control uses a transformer to supply 12 VDC. Please make sure your voltage supply is compatible with your unit before installation.

Existing Plumbing

Condition of existing plumbing should be free from lime and iron buildup. Piping that is built up heavily with lime and/or iron should be replaced. If piping is clogged with iron, a separate iron filter unit should be installed ahead of the water softener.

Location of Softener and Drain

You must have an air gap on the drain line to prevent back flow of drain water into the system. A 2x the drain line pipe diameter air gap is required with a minimum 1" air gap.

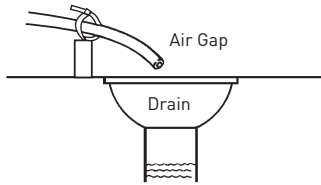

Figure 1 Air Gap

Installation Locations

FOR DRY LOCATIONS ONLY.

Bypass Valves

Always provide for the installation of a bypass valve if unit is not equipped with one.

CAUTION Water pressure is not to exceed 125 psi (8.6 bar), water temperature is not to exceed 110°F (43°C), and the unit cannot be subjected to freezing conditions.

WARNING: The system must be depressurized before removing any connections for servicing.

Installation Instructions

1. Place the softener tank where you want to install the unit. Make sure the unit is level and on a firm base.
2. During cold weather, the installer should warm the valve to room temperature before operating.
3. All plumbing should be done in accordance with local plumbing codes. The pipe size for a residential drain line should be a minimum of 1/2" (13 mm). Backwash flow rates in excess of 7 gpm (26.5 Lpm) or drain line length in excess of 20' (6 m) require 3/4" (19 mm) drain line. Commercial drain lines should be the same size as the drain line flow control.

NOTE: NOTE: The tank should have the distributor tube installed and have the proper amount of regenerant in place.

4. Refer to the spec sheet for cutting height of the distributor tube.

5. Lubricate the distributor O-ring seal and tank O-ring seal. Place the main control valve on tank. Note: Only use silicone lubricant.
6. Soldering of joints near the drain port must be done prior to connecting the Drain Line Flow Control fitting (DLFC). Leave at least 6" (15 cm) between the DLFC and solder joints when soldering pipes that are connected on the DLFC. Failure to do this could cause interior damage to the DLFC.
7. PTFE plumbing tape is the only sealant to be used on the drain fitting.
8. Make sure that the floor is clean beneath the salt storage tank and that the tank is level.
9. Place approximately 1" (25 mm) of water above the grid plate. If a grid is not utilized, fill to the top of the air check (Figure 1) in the salt tank. Do not add salt to the brine tank at this time.

CAUTION If grid plate is used, cut air check height even with grid plate. This is critical on 6", 7", 8" and 9" tanks. The brine refill water must come above the grid plate and make contact with the salt.

10. On units with a bypass, place in bypass position. Turn on the main water supply. Open a cold soft water tap nearby and let run a few minutes or until the plumbing is free from foreign material (usually solder) that may have resulted from the installation. Once clean, close the water tap.
11. Slowly place the bypass in service position and let water flow into the mineral tank. When water flow stops, slowly open a cold water tap nearby and let water run until the air is purged from the plumbing lines.
12. Plug the transformer into an electrical outlet.

NOTE: NOTE: All electrical connections must be connected according to local codes. Be certain the outlet is uninterrupted.

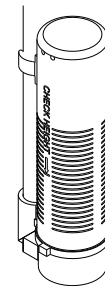

Figure 2 Residential Air Check Valve

Electrical Connection

The controller operates on 12-volt DC power supply. Do not operate the controller with a power supply other than the one supplied by the manufacturer for this model.

NOTE: The power source should be constant. Be certain the power adapter is not on a switched outlet. Power interruptions longer than 8 hours may cause the controller to lose the time setting. When power is restored, the time setting must then be re-entered.

START-UP INSTRUCTIONS/ FLUSHING & CONDITIONING

The water softener should be installed with the inlet, outlet, and drain connections made in accordance with the manufacturer's recommendations, and to meet applicable plumbing codes.

1. Program the valve control according to instructions shown in this manual.
2. Start an immediate regeneration by holding the Extra Cycle button for five seconds. Position the valve to backwash. Ensure the drain line flow remains steady for 10 minutes or until the water runs clear.
3. Position the valve to the brine draw / slow rinse position. Ensure the unit is drawing water from the brine tank (this step may need to be repeated).
4. Position the valve to the rapid rinse position. Check the drain line flow, and run for five minutes or until the water runs clear.
5. Position the valve to the start of the brine tank fill cycle. Ensure water goes into the brine tank at the desired rate. The brine valve drive cam will hold the valve in this position to fill the brine tank for the first regeneration.
6. Replace control cover.
7. Put salt in the brine tank.

NOTE: Do not use granulated or rock salt.

CONTROL FEATURES

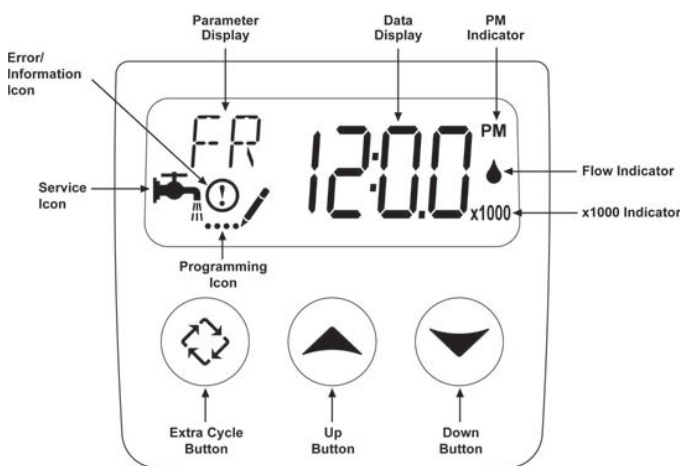

Figure 3

Features of the SXT:

- Power backup that continues to keep time and the passage of days for a minimum of 8 hours in the event of power failure. During a power outage, the control goes into a power-saving mode. It does not monitor water usage during a power failure, but it does store the volume remaining at the time of power failure.
- Settings for both valve (basic system) and control type (method used to trigger a regeneration).
- Day-of-the-Week controls.
- While in service, the display alternates between time of day, volume remaining or days to regeneration.
- The Flow Indicator flashes when outlet flow is detected.
- The Service Icon flashes if a regeneration cycle has been queued.
- A Regeneration can be triggered immediately by pressing the Extra Cycle button for five seconds.
- The Parameter Display displays the current cycle step (BW, BF, RR etc) during regeneration, and the data display counts down the time remaining for that cycle step. While the valve is transferring to a new cycle step, the display will flash. The parameter display will identify the destination cycle step (BW, BF, RR, etc.) and the data display will read "-----". Once the valve reaches the cycle step, the display will stop flashing and the data display will change to the time remaining. During regeneration, the user can force the control to advance to the next cycle step immediately by pressing the Extra Cycle button.

Setting the Time of Day

1. Press and hold either the Up or Down buttons until the programming icon replaces the service icon and the parameter display reads TD.
2. Adjust the displayed time with the Up and Down buttons.
3. When the desired time is set, press the Extra Cycle button to resume normal operation. The unit will also return to normal operation after five seconds if no buttons are pressed.

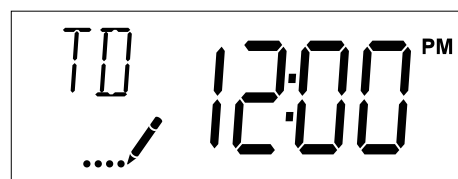

Figure 4

Queueing a Regeneration

1. Press the Extra Cycle button. The service icon will flash to indicate that a regeneration is queued.
2. To cancel a queued regeneration, press the Extra Cycle button.

Regenerating Immediately

Press and hold the Extra Cycle button for five seconds.

TIMER OPERATION

Meter Immediate Control

A meter immediate control measures water usage and regenerates the system as soon as the calculated system capacity is depleted. The control calculates the system capacity by dividing the unit capacity (typically expressed in grains/unit volume) by the feed water hardness and subtracting the reserve. Meter Immediate systems generally do not use a reserve volume. However, in twin tank systems with soft-water regeneration, the reserve capacity should be set to the volume of water used during regeneration to prevent hard water break-through. A Meter Immediate control will also start a regeneration cycle at the programmed regeneration time if a number of days equal to the regeneration day override pass before water usage depletes the calculated system capacity.

Meter Delayed Control

A Meter Delayed Control measures water usage and regenerates the system at the programmed regeneration time after the calculated system capacity is depleted. As with Meter Immediate systems, the control calculates the system capacity by dividing the unit capacity by the feed water hardness and subtracting the reserve. The reserve should be set to insure that the system delivers treated water between the time the system capacity is depleted and the actual regeneration time. A Meter Delayed control will also start a regeneration cycle at the programmed regeneration time if a number of days equal to the regeneration day override pass before water usage depletes the calculated system capacity.

Time Clock Delayed Control

A Time Clock Delayed Control regenerates the system on a timed interval. The control will initiate a regeneration cycle at the programmed regeneration time when the number of days since the last regeneration equals the regeneration day override value.

Day of the Week Control

This control regenerates the system on a weekly schedule. The schedule is defined in Master Programming by setting each day to either "off" or "on." The control will initiate a regeneration cycle on days that have been set to "on" at the specified regeneration time.

Control Operation During Regeneration

During regeneration, the control displays a special regeneration display. In this display, the control shows the current regeneration step number the valve is advancing to, or has reached, and the time remaining in that step. The step number that displays flashes until the valve completes driving to this regeneration step position. Once all regeneration steps are complete the valve returns to service and resumes normal operation.

Pressing the Extra Cycle button during a regeneration cycle immediately advances the valve to the next cycle step position and resumes normal step timing.

Control Operation During Programming

The control only enters the Program Mode with the valve in service. While in the Program Mode, the control continues to operate normally monitoring water usage and keeping all displays up to date. Control programming is stored in memory permanently, eliminating the need for battery backup power.

Manually Initiating a Regeneration

1. When timer is in service, press the Extra Cycle button for 5 seconds on the main screen.
2. The timer advances to Regeneration Cycle Step #1 (backwash), and begins programmed time count down.
3. Press the Extra Cycle button once to advance valve to Regeneration Cycle Step #2 (brine draw & slow rinse).
4. Press the Extra Cycle button once to advance valve to Regeneration Cycle Step #3 (rapid rinse).
5. Press the Extra Cycle button once to advance valve to Regeneration Cycle Step #4 (brine refill).
6. Press the Extra Cycle button once more to advance the valve back to in service.

NOTE: If the unit is a filter or upflow, the cycle step order may change.

NOTE: A queued regeneration can be initiated by pressing the Extra Cycle button. To clear a queued regeneration, press the Extra Cycle button again to cancel. If regeneration occurs for any reason prior to the delayed regeneration time, the manual regeneration request shall be cleared.

Control Operation During a Power Failure

The SXT includes integral power backup. In the event of power failure, the control shifts into a power-saving mode. The control stops monitoring water usage, and the display and motor shut down, but it continues to keep track of the time and day for a minimum of 48 hours.

The system configuration settings are stored in a non-volatile memory and are stored indefinitely with or without line power. The Time of Day flashes when there has been a power failure. Press any button to stop the Time of Day from flashing.

If power fails while the unit is in regeneration, the control will save the current valve position before it shuts down. When power is restored, the control will resume the regeneration cycle from the point where power failed. Note that if power fails during a regeneration cycle, the valve will remain in its current position until power is restored. The valve system should include all required safety components to prevent overflows resulting from a power failure during regeneration.

The control will not start a new regeneration cycle without line power. If the valve misses a scheduled regeneration due to a power failure, it will queue a regeneration. Once power is restored, the control will initiate a regeneration cycle the next time that the Time of Day equals the programmed regeneration time. Typically, this means that the valve will regenerate one day after it was originally scheduled. If the treated water output is important and power interruptions are expected, the system should be setup with a sufficient reserve capacity to compensate for regeneration delays.

USER PROGRAMMING

The 5800 SXT control was designed to operate under most conditions with minimal programming. Follow the procedure below to set up the control for normal operation. For more in-depth programming information, see the Master Programming section.

Abbreviation	Parameter	Description
DO	Day Override	The control's day override setting.
RT	Regeneration Time	The time of the day that the system will regenerate (meter delayed, time clock, and day-of-week systems)
H	Feed Water Hardness	The hardness of the inlet water - used to calculate system capacity for metered systems.
RC or SF	Reserve Capacity or Safety Factor	The fixed reserve capacity of the system in gallons to maintain before the next scheduled regeneration. Can also be set as a percentage of total capacity. See Master Programming section..
CD	Current Day	The current day of week.

NOTE: Some items may not be shown depending on control configuration. The control will discard any changes and exit User Programming Mode if a button is not pressed for 60 seconds.

NOTE: When variable reserve (cr) is selected from Master Programming, User Programming will display SF. However, changing the value of SF will have no effect when variable reserve is selected in Master Programming.

User Programming Mode Steps

1. Press the Up and Down buttons for five seconds while in service, and the time of day is NOT set to 12:01 PM.
2. Use this display to adjust the Day Override. This option setting is identified by "DO" in the upper left corner of the screen.



Figure 5

3. Press the Extra Cycle button. Use this display to adjust the Regeneration Time. This option setting is identified by "RT" in the upper left corner of the screen.

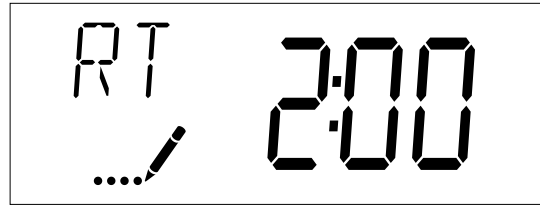

Figure 6

4. Press the Extra Cycle button. Use this display to adjust the Feed Water Hardness. This option setting is identified by "H" in the upper left corner of the screen.



Figure 7

Range: 1-199 hardness

5. Press the Extra Cycle button. Use this display to adjust the Fixed Reserve Capacity. This option setting is identified by "RC" or "SF" in the upper left corner of the screen.

NOTE: NOTE: This setting is dependent upon Reserve Selection setting in Master Programming. Default is RC - Reserve Capacity (Gallons). See Master Programming section for more information.

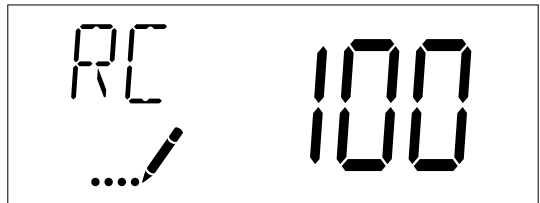

Figure 8

6. Press the Extra Cycle button. Use this display to set the Current Day of the Week. This option setting is identified by "CD" in the upper left corner of the screen.



Figure 9

7. Press the Extra Cycle button to end User Programming.

MASTER PROGRAMMING MODE CHART

CAUTION Before entering Master Programming, please contact your local professional water dealer. To enter Master Programming, set time to 12:01 PM.

Master Programming Options			
Abbreviation	Parameter	Option Abbreviation	Options
DF	Display Format	GAL	Gallons
		Ltr	Liters
VT	Valve Type	dF1b	Downflow/Upflow Single Backwash
		dF2b	Downflow Double Backwash
		Fltr	Filter
		UFbd	Upflow Brine First
		UFtr	Upflow Filter
		Othr	Other
CT	Control Type	Fd	Meter (Flow) Delayed
		FI	Meter (Flow) Immediate
		tc	Time Clock
		dAY	Day of Week
NT	Number of Tanks	1	Single Tank System
		2	Two Tank System
TS	Tank in Service	U1	Tank 1 in Service
		U2	Tank 2 in Service
C	Unit Capacity		Unit Capacity (Grains)
H	Feedwater Hardness		Hardness of Inlet Water (Grains)
RS	Reserve Selection	SF	Percentage Safety Factor
		rc	Fixed Reserve Capacity
SF	Safety Factor		Percentage of the system capacity to be used as a reserve
RC	Fixed Reserve Capacity		Fixed volume to be used as a reserve
DO	Day Override		The system's day override setting
RT	Regen Time		The time of day the system will regenerate
BW, BD, RR, BF	Regen Cycle Step Times		The time duration for each regeneration step. Adjustable from OFF and 0-199 minutes. NOTE: If "Othr" is chosen under "Valve Type", then R1, R2, R3, etc, will be displayed instead
D1, D2, D3, D4, D5, D6, & D7	Day of Week Settings		Regeneration setting (On or OFF) for each day of the week on day-of-week systems
CD	Current Day		The Current day of the week
FM	Flow Meter Type	t0.7	3/4-inch Turbine Meter
		P0.7	3/4-inch Paddle Wheel Meter
		t1.0	1-inch Turbine Meter
		P1.0	1-inch Paddle Wheel Meter
		t1.5	1.5-inch Turbine Meter
		P1.5	1.5-inch Paddle Wheel Meter
		P2.0	2-inch Paddle Wheel Meter
Gen	Generic or Other Meter		
K	Meter Pulse Setting		Meter pulses per gallon/liter for generic/other flow meter

NOTE: Some items may not be shown depending on timer configuration. The timer will discard any changes and exit Master Programming Mode if any button is not pressed for sixty seconds.

MASTER PROGRAMMING MODE

When the Master Programming Mode is entered, all available option setting displays may be viewed and set as needed. Depending on current option settings, some parameters cannot be viewed or set.

Setting the Time of Day

1. Press and hold either the Up or Down buttons until the programming icon replaces the service icon and the parameter display reads TD.
2. Adjust the displayed time with the Up and Down buttons.
3. When the desired time is set, press the Extra Cycle button to resume normal operation. The unit will also return to normal operation after 5 seconds if no buttons are pressed.



Entering Master Programming Mode

Set the Time Of Day display to 12:01 PM. Press the Extra Cycle button (to exit Setting Time of Day mode). Then press and hold the Up and Down buttons together until the programming icon replaces the service icon and the Display Format screen appears.

Exiting Master Programming Mode

Press the Extra Cycle button to accept the displayed settings and cycle to the next parameter. Press the Extra Cycle button at the last parameter to save all settings and return to normal operation. The control will automatically disregard any programming changes and return to normal operation if it is left in Master Programming mode for 5 minutes without any keypad input.

Resets

Soft Reset: Press and hold the Extra Cycle and Down buttons for 25 seconds while in normal Service mode. This resets all parameters to the system default values, except the volume remaining in meter immediate or meter delayed systems and days since regeneration in the time clock system.

Master Reset: Hold the Extra Cycle button while powering up the unit. This resets all of the parameters in the unit. Check and verify the choices selected in Master Programming Mode.

1. Display Format (Display Code DF)

This is the first screen that appears when entering Master Programming Mode. The Display Format setting specifies the unit of measure that will be used for volume and how the control will display the Time of Day. This option setting is identified by "DF" in the upper left hand corner of the screen. There are two possible settings:

Display Format Setting	Unit of Volume	Time Display
GAL	U.S. Gallons	12-Hour AM/PM
Ltr	Liters	24-Hour

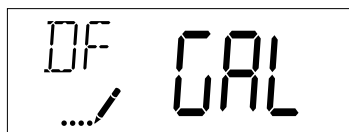

2. Valve Type (Display Code VT)

Press the Extra Cycle button. Use this display to set the Valve Type. The Valve Type setting specifies the type of cycle that the valve follows during regeneration. Note that some valve types require that the valve be built with specific subcomponents. Ensure the valve is configured properly before changing the Valve Type setting. This option setting is identified by "VT" in the upper left hand corner of the screen. There are six possible settings:

Abbreviation	Parameter
dF1b	Downflow/Upflow, Single Backwash
dF2b	Downflow Double Backwash
Fltr	Filter
UFbd	Upflow Brine First
UFtr	Upflow Filter
Othr	Other

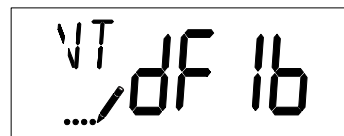

3. Control Type (Display Code CT)

Press the Extra Cycle button. Use this display to set the Control Type. This specifies how the control determines when to trigger a regeneration. For details on how the various options function, refer to the "Timer Operation" section of this service manual. This option setting is identified by "CT" in the upper left hand corner of the screen. There are four possible settings:

Meter Delayed: Fd
 Meter Immediate: FI
 Time Clock: tc
 Day of Week: dAY

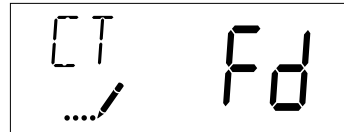

4. Number of Tanks (Display Code NT)

Press the Extra Cycle button. Use this display to set the Number of Tanks in your system. This option setting is identified by "NT" in the upper left hand corner of the screen. There are two possible settings:

Single Tank System: 1
 Two-Tank System: 2

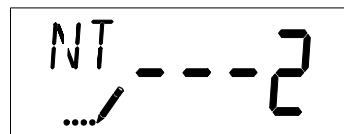

MASTER PROGRAMMING MODE *CONTINUED*

5. Tank in Service (Display Code TS)

Press the Extra Cycle button. Use this display to set whether tank one or tank two is in service. This option setting is identified by "TS" in the upper left hand corner of the screen. This parameter is only available if the number of tanks has been set to 2. There are two possible settings:

Tank One in Service: U1

Tank Two in Service: U2

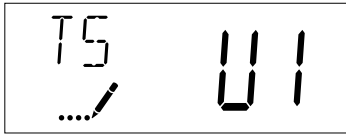

6. Unit Capacity (Display Code C)

Press the Extra Cycle button. Use this display to set the Unit Capacity. This setting specifies the treatment capacity of the system media. Enter the capacity of the media bed in grains of hardness when configuring a softener system, and in the desired volume capacity when configuring a filter system. This option setting is identified by "C" in the upper left hand corner of the screen. The Unit Capacity parameter is only available if the control type has been set to one of the metered options. Use the Up and Down buttons to adjust the value as needed.

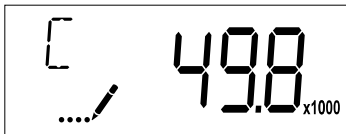

Range: 1-999,900 gallons (100-9,999,000 Liters)

7. Feedwater Hardness (Display Code H)

Press the Extra Cycle button. Use this display to set the Feedwater Hardness. Enter the feedwater hardness in grains per unit volume for softener systems, or 1 for filter systems. This option setting is identified by "H" in the upper left hand corner of the screen. The feedwater hardness parameter is only available if the control type has been set to one of the metered options. Use the Up and Down buttons to adjust the value as needed.

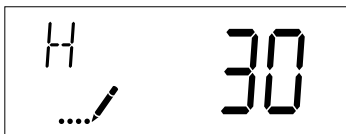

Range: 1-199 hardness

8. Reserve Selection (Display Code RS)

Press the Extra Cycle button. Use this display to set the Safety Factor. Use this display to select the type of reserve to be used in your system. This setting is identified by "RS" in the upper left-hand corner of the screen. The reserve selection parameter is only available if the control type has been set to one of the metered options. There are two possible settings.

FS	Safety Factor
rc	Fixed Reserve Capacity

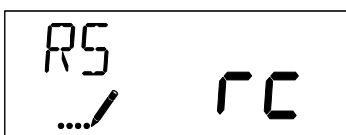

9. Safety Factor (Display Code SF)

Press the Extra Cycle button. Use this display to set the Safety Factor. This setting specifies what percentage of the system capacity will be held as a reserve. Since this value is expressed as a percentage, any change to the unit capacity or feedwater hardness that changes the calculated system capacity will result in a corresponding change to the reserve volume. This option setting is identified by "SF" in the upper left hand corner of the screen. Use the Up and Down buttons to adjust the value from 0 to 50% as needed.

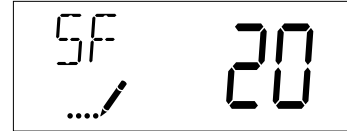

Range: 0-50%

10. Fixed Reserve Capacity (Display Code RC)

Press the Extra Cycle button. Use this display to set the Reserve Capacity. This setting specifies a fixed volume that will be held as a reserve. The reserve capacity cannot be set to a value greater than one-half of the calculated system capacity. The reserve capacity is a fixed volume and does not change if the unit capacity or feedwater hardness are changed. This option setting is identified by "RC" in the upper left-hand corner of the screen. Use the Up and Down buttons to adjust the value as needed.

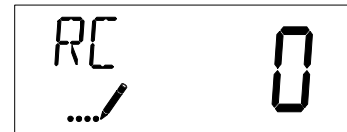

Range: 0-half the calculated capacity

11. Day Override (Display Code DO)

Press the Extra Cycle button. Use this display to set the Day Override. This setting specifies the maximum number of days between regeneration cycles. If the system is set to a timer-type control, the day override setting determines how often the system will regenerate. A metered system will regenerate regardless of usage if the days since last regeneration cycle equal the day override setting. Setting the day override value to "OFF" disables this function. This option setting is identified by "DO" in the upper left hand corner of the screen. Use the Up and Down buttons to adjust the value as needed.

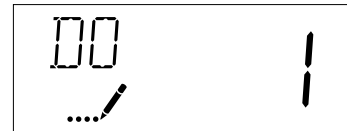

Range: Off-99 days

12. Regeneration Time

Press the Extra Cycle button. Use this display to set the Regeneration Time. This setting specifies the time of day the control will initiate a delayed, manually queued, or day override triggered regeneration. This option setting is identified by "RT" in the upper left hand corner of the screen. Use the Up and Down buttons to adjust the value as needed.

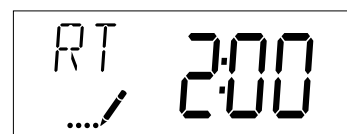

MASTER PROGRAMMING MODE *CONTINUED*

13. Regeneration Cycle Step Times

Press the Extra Cycle button. Use this display to set the Regeneration Cycle Step Times. The different regeneration cycles are listed in sequence based on the valve type selected for the system, and are identified by an abbreviation in the upper left-hand corner of the screen. The abbreviations used are listed below. If the system has been configured with the "OTHER" valve type, the regeneration cycles will be identified as R1, R2, R3, R4, R5, and R6. Each cycle step time can be set from 0 to 199 minutes. Setting a cycle step time to 0 will cause the control to skip that step during regeneration, but keeps the following steps available. Use the Up and Down buttons to adjust the value as needed. Press the Extra Cycle button to accept the current setting and move to the next parameter.

Abbreviation	Cycle Step
BD	Brine Draw
BF	Brine Fill
BW	Backwash
RR	Rapid Rinse
SV	Service



Range: 0-199 minutes

14. Day of Week Settings

Press the Extra Cycle button. Use this display to set the regeneration schedule for a system configured as a Day of Week control. The different days of the week are identified as D1, D2, D3, D4, D5, D6, and D7 in the upper left-hand corner of the display. Set the value to "ON" to schedule a regeneration or "OFF" to skip regeneration for each day. Use the Up and Down buttons to adjust the setting as needed. Press the Extra Cycle button to accept the setting and move to the next day. Note that the control requires at least one day to be set to "ON." If all 7 days are set to "OFF", the unit will return to Day One until one or more days are set to "ON."

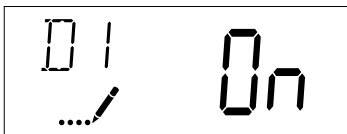

15. Current Day (Display Code CD)

Press the Extra Cycle button. Use this display to set the current day on systems that have been configured as Day of Week controls. This setting is identified by "CD" in the upper left-hand corner of the screen. Use the Up and Down buttons to select from Day 1 through Day 7.



16. Flow Meter Type (Display Code FM)

Press the Extra Cycle button. Use this display to set the type of flow meter connected to the control. This option setting is identified by "FM" in the upper left-hand corner of the screen. Use the Up and Down buttons to select one of the seven available settings.

t0.7	Fleck 3/4-inch Turbine Meter
P0.7	Fleck 3/4-inch Paddle Wheel Meter
t1.0	Fleck 1-inch Turbine Meter
P1.0	Fleck 1-inch Paddle Wheel Meter
t1.5	Fleck 1-1/2 inch Turbine Meter
P1.5	Fleck 1-1/2 inch Paddle Wheel Meter
P2.0	Fleck 2-inch Paddle Wheel Meter
GEn	Generic/Other Meter

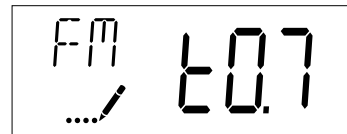

17. Meter Pulse Setting (Display Code K)

Press the Extra Cycle button. Use this display to specify the meter pulse setting for a non-standard flow meter. This option setting is identified by "K" in the upper left-hand corner of the screen. Use the Up and Down buttons to enter the meter constant in pulses per unit volume.



18. End of Master Programming Mode

Press the Extra Cycle button to save all settings and exit Master Programming Mode.

USER PROGRAMMING MODE

User Programming Mode Options		
Abbreviation	Parameter	Description
DO	Day Override	The timer's day override setting
RT	Regeneration Time	The time of day that the system will regenerate (meter delayed, time clock, and day-of-week systems)
H	Feed Water Hardness	The hardness of the inlet water - used to calculate system capacity for metered systems
RC or SF	Reserve Capacity	The fixed reserve capacity
CD	Current Day	The current day of week

NOTE: Some items may not be shown depending on timer configuration. The timer will discard any changes and exit User Mode if any button is not pressed for sixty seconds.

User Programming Mode Steps

1. Press the Up and Down buttons for five seconds while in service, and the time of day is NOT set to 12:01 PM.
2. Use this display to adjust the Day Override. This option setting is identified by "DO" in the upper left hand corner of the screen.



3. Press the Extra Cycle button. Use this display to adjust the Regeneration Time. This option setting is identified by "RT" in the upper left hand corner of the screen.

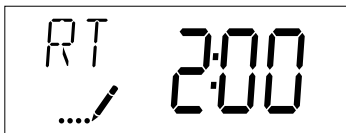

4. Press the Extra Cycle button. Use this display to adjust the Feed Water Hardness. This option setting is identified by "H" in the upper left hand corner of the screen.

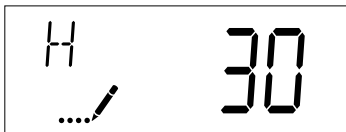

Range: 1-199 hardness

5. Press the Extra Cycle button. Use this display to adjust the Fixed Reserve Capacity. This option setting is identified by "RC" or "SF" in the upper left-hand Corner of the screen.

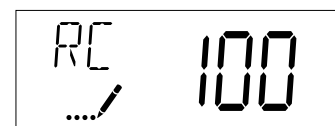

6. Press the Extra Cycle button. Use this display to set the Current Day of the Week. This option setting is identified by "CD" in the upper left hand corner of the screen.

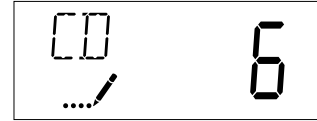

7. Press the Extra Cycle button to end User Programming Mode.

DIAGNOSTIC PROGRAMMING MODE

Diagnostic Programming Mode Options		
Abbreviation	Parameter	Description
FR	Flow Rate	Displays the current outlet flow rate
PF	Peak Flow Rate	Displays the highest flow rate measured since the last regeneration
HR	Hours in Service	Displays the total hours that the unit has been in service
VU	Volume Used	Displays the total volume of water treated by the unit
RC	Reserve Capacity	Displays the system's reserve capacity calculated from the system capacity, feedwater hardness, and safety factor
SV	Software Version	Displays the software version installed on the controller

NOTE: Some items may not be shown depending on timer configuration. The timer will exit Diagnostic Mode after 60 seconds if no buttons are pressed. Press the Extra Cycle button to exit Diagnostic Mode at any time.

Diagnostic Programming Mode Steps

1. Press the Up and Extra Cycle buttons for five seconds while in service.
2. Use this display to view the current Flow Rate. This option setting is identified by "FR" in the upper left hand corner of the screen.

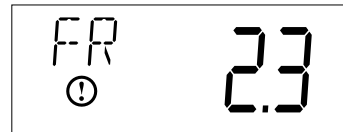

3. Press the Up button. Use this display to view the Peak Flow Rate since the last regeneration cycle. This option setting is identified by "PF" in the upper left hand corner of the screen.

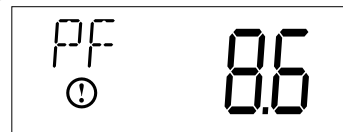

DIAGNOSTIC PROGRAMMING MODE

CONTINUED

4. Press the Up button. Use this display to view the Hours in Service since the last regeneration cycle. This option setting is identified by "HR" in the upper left hand corner of the screen.



5. Press the Up button. Use this display to view the Volume Used since the last regeneration cycle. This option setting is identified by "VU" in the upper left hand corner of the screen.

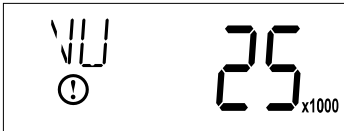

6. Press the Up button. Use this display to view the Reserve Capacity. This option setting is identified by "RC" in the upper left hand corner of the screen.



7. Press the Up button. Use this display to view the Software Version. This option setting is identified by "SV" in the upper left hand corner of the screen.



8. Press the Extra Cycle button to end Diagnostic Programming Mode.

56SXT SOFTENER METER

Item No.	QTY	Part No.	Description
1	1	560006-001	5600, SOF, DNF, MTR, SXT-, 24-60, CW 1--, .5-, LES, NA2, 1600, SOFT
		560006-009	5600, SOF, DNF, MTR, SXT-, 24-60, CW 1--, .5-, LES, NA2, 1600, SOFT
		560006-002	5600, SOF, DNF, MTR, SXT-, 24-60, CW 1--, .5-, LES, NA2, 1600, SOFT
		560006-003	5600, SOF, DNF, MTR, SXT-, 24-60, CW 1--, .5-, LES, NA2, 1600, SOFT
		560006-012	5600, SOF, DNF, MTR, SXT-, 24-60, CW 1--, .5-, LES, NA2, 1600, SOFT

NOTE: NOTE: Above part numbers DO NOT include the following parts.

Bypass Assembly
Yoke Assembly
DLFC with Retainer
Flow Washers

See accessory page for options.

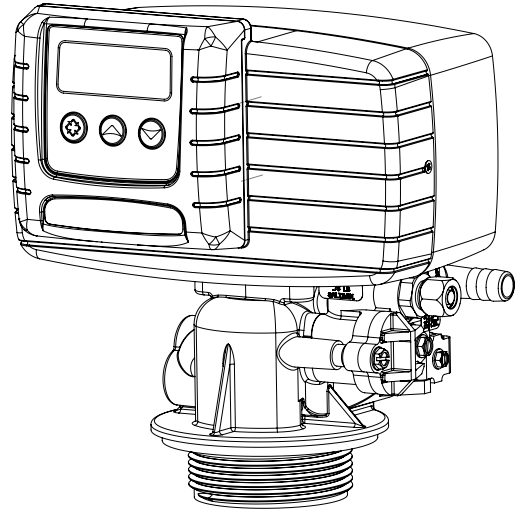

56SXT SOFTENER TIME CLOCK

Item No.	QTY	Part No.	Description
1	1	560006-008	5600, SOF, DNF, CLK, SXT-, 24-60, CW 1--, .5-, LES, NA2, 1600, SOFT
		560006-011	5600, SOF, DNF, CLK, SXT-, 24-60, CW 1--, .5-, LES, NA2, 1600, SOFT

NOTE: NOTE: Above part numbers DO NOT include the following parts.

Bypass Assembly
Yoke Assembly
DLFC with Retainer
Flow Washers

See accessory page for options.

56SXT BACKWASH FILTER TIME CLOCK

Item No.	QTY	Part No.	Description
1	1	560006-006	5600, FIL, DNF, CLK, SXT-, 24-50, CW BWF, BWF, LES, BWF-, FILT
		560006-007	5600, FIL, DNF, CLK, SXT-, 24-60, CW BWF, BWF, LES, BWF-, FILT
		560006-010	5600, FIL, DNF, CLK, SXT-, 24-60, CW BWF, BWF, LES, BWF-, FILT

NOTE: Above part numbers DO NOT include the following parts.

Bypass Assembly
Yoke Assembly
DLFC with Retainer
Flow Washers

See accessory page for options.

56SXT VALVE ACCESSORIES

Bypasses

60041SS.....	1" Bypass, SS, NPT
60040SS.....	3/4" Bypass, SS, NPT
60049.....	Bypass, Plastic

Yokes

19620-01	Yoke Assy, 3/4", r/angle, 90 deg.
18706.....	1" Yoke, Plastic NPT
18706-10	1" Yoke, Plastic BSP
18706-02	3/4" Yoke, Plastic NPT
18706-12	3/4" Yoke, Plastic BSP
61694.....	1" Yoke, QC
61700.....	3/4" Yoke, QC
13708-40	1" Yoke, Sweat
41026-01	1" Yoke, SS, NPT
42690.....	3/4" Yoke, Sweat
41027-01	3/4" Yoke, SS, NPT

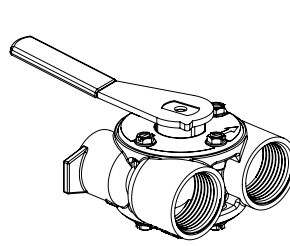

BYPASS

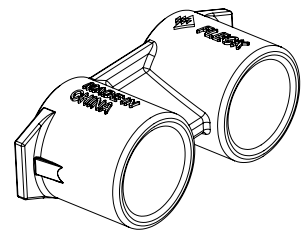

YOKE

Washers

19153.....	Washer, Flow, 0.6 GPM
19152.....	Washer, Flow, 0.8 GPM
12085.....	Washer, Flow, 1.2 GPM
19150.....	Washer, Flow, 1.3 GPM
12086.....	Washer, Flow, 1.5 GPM
19149.....	Washer, Flow, 1.7 GPM
12087.....	Washer, Flow, 2.0 GPM
12088.....	Washer, Flow, 2.4 GPM
12089.....	Washer, Flow, 3.0 GPM
12090.....	Washer, Flow, 3.5 GPM
12091.....	Washer, Flow, 4.0 GPM
19147.....	Washer, Flow, 4.5 GPM
12092.....	Washer, Flow, 5.0 GPM
17814.....	Washer, Flow, 6.0 GPM
12408.....	Washer, Flow, 7.0 GPM

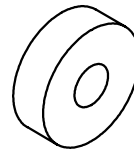

WASHER

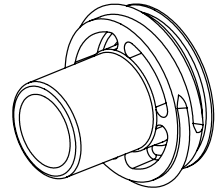

RETAINER

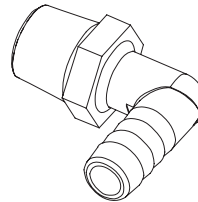

DRAIN ELBOW

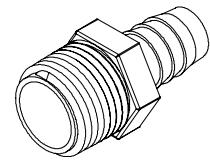

HOSE BARBS

Retainer

13173-01	Retainer, DLFC Button, w/O-ring
----------------	---------------------------------

Drain Elbows

12338.....	1/2" Drain Elbow, 90
19699.....	1/2" Drain Elbow, 45
13121.....	5/8" Drain Elbow, 90

Hose Barbs

13308.....	1/2" Straight Hose Barb
13308-01	5/8" Straight Hose Barb

Collectors

18280.....	Top Collector, 1.050
18280-02	Top Collector, 1.050 Narrow
18280-01	Top Collector, 1.050 Wide

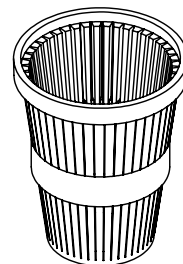

COLLECTOR

56SXT VALVE ASSEMBLIES

BLFC

- 60022-12BLFC, 0.125 GPM (0.375 lbs NaCl/min)
- 60022-25BLFC, 0.25 GPM (0.75 lbs NaCl/min)
- 60022-50BLFC, 0.50 GPM (1.5 lbs NaCl/min)
- 60022-100BLFC, 1.0 GPM (3 lbs NaCl/min)

Injector Drain Assemblies

- 60084-0001.....Injector Drain Assy,
5600, #0, Blank DLFC, .25 BLFC
- 60084-0002.....Injector Drain Assy,
5600, #0, Blank DLFC, .50 BLFC
- 60084-0101.....Injector Drain Assy,
5600, #1, Blank DLFC, .25 BLFC
- 60084-0102.....Injector Drain Assy,
5600, #1, Blank DLFC, .50 BLFC

Injector Nozzles

- 10913-0Nozzle, Injector, #0, Red (8" Tank)
- 10913-00Nozzle, Injector, #00, Violet (7" Tank)
- 10913-000Nozzle, Injector, #000, Brown (6" Tank)
- 10913-1Nozzle, Injector, #1, White (9" & 10" Tank)
- 10913-2Nozzle, Injector, #2, Blue (12" Tank)
- 10913-3Nozzle, Injector, #3, Yellow (13" Tank)
- 10913-4Nozzle, Injector, #4, Green (14" Tank)
- 10913BLK.....Nozzle, Injector, Black (Filter)

Injector Throats

- 10914-0Throat, Injector, #0, Red (8" Tank)
- 10914-00Throat, Injector, #00, Violet (7" Tank)
- 10914-000Throat, Injector, #000, Brown (6" Tank)
- 10914-1Throat, Injector, #1, White (9" & 10" Tank)
- 10914-2Throat, Injector, #2, Blue (12" Tank)
- 10914-3Throat, Injector, #3, Yellow (13" Tank)
- 10914-4Throat, Injector, #4, Green (14" Tank)

Plugs

- 40947-02Plug, Brine Valve, w/o-ring
- 13918-01BLFC Module Plug Assy, w/o-ring

Switches

- 60320-03Switch Assy, 5600 Auxiliary

Brine Cam Assemblies

- 60514-00Brine Cam Assy, 5600, Less Salt Label

Powerheads

- 62096-01Pwrhd, 56SXT, Mtr-Pdl, DF, Sqarcvr,
24/60 w/Transformer
- 62096-02Pwrhd, 56SXT, Mtr-Pdl, DF, Curvcvr,
24/60 w/Transformer
- 62096-03Pwrhd, 56SXT, Mtr-Tur, DF, Sqarcvr,
24/60 w/Transformer
- 62096-04Pwrhd, 56SXT, Mtr-Tur, DF, Curvcvr,
24/60 w/Transformer
- 62097-01Pwrhd, 56SXT, Clk, DF, Sqarcvr,
24/60 w/Transformer
- 62097-02Pwrhd, 56SXT, Clk, DF, Curvcvr,
24/60 w/Transformer

Meters

- 60086-50Meter Assy, 3/4" Dual Port, Slip Elec
Plas, Pdl, w/Clps
- 19121-01Meter Cable Assy, SE, Paddle
- 60626.....Meter Assy, Turbine, Electronic 3/4"
with clips and screws
- 19791-01Meter Cable Assy, Turbine/SXT

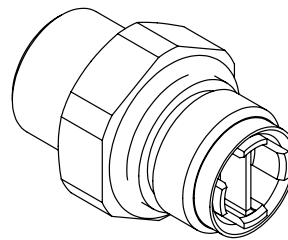

BLFC

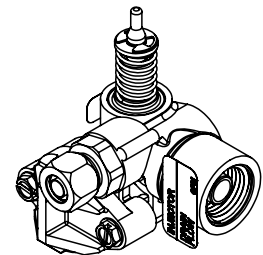

INJECTOR DRAIN ASSY

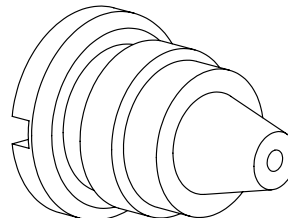

INJECTOR NOZZLE

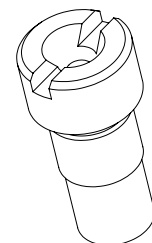

INJECTOR THROAT

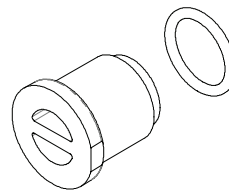

PLUG

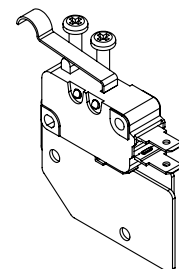

SWITCH

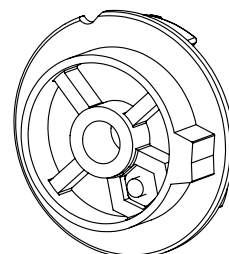

BRINE CAM ASSY

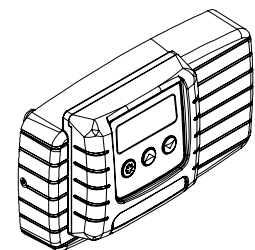

POWERHEAD, SQUARE

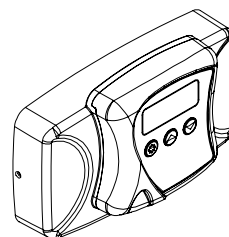

POWERHEAD, CURVED

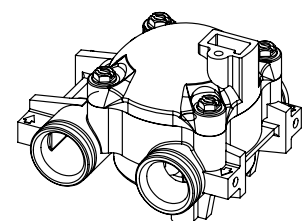

METER ASSY, PADDLE

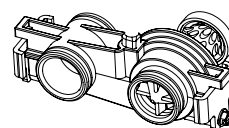

METER ASSY, TURBINE

CONTROL VALVE ASSEMBLY

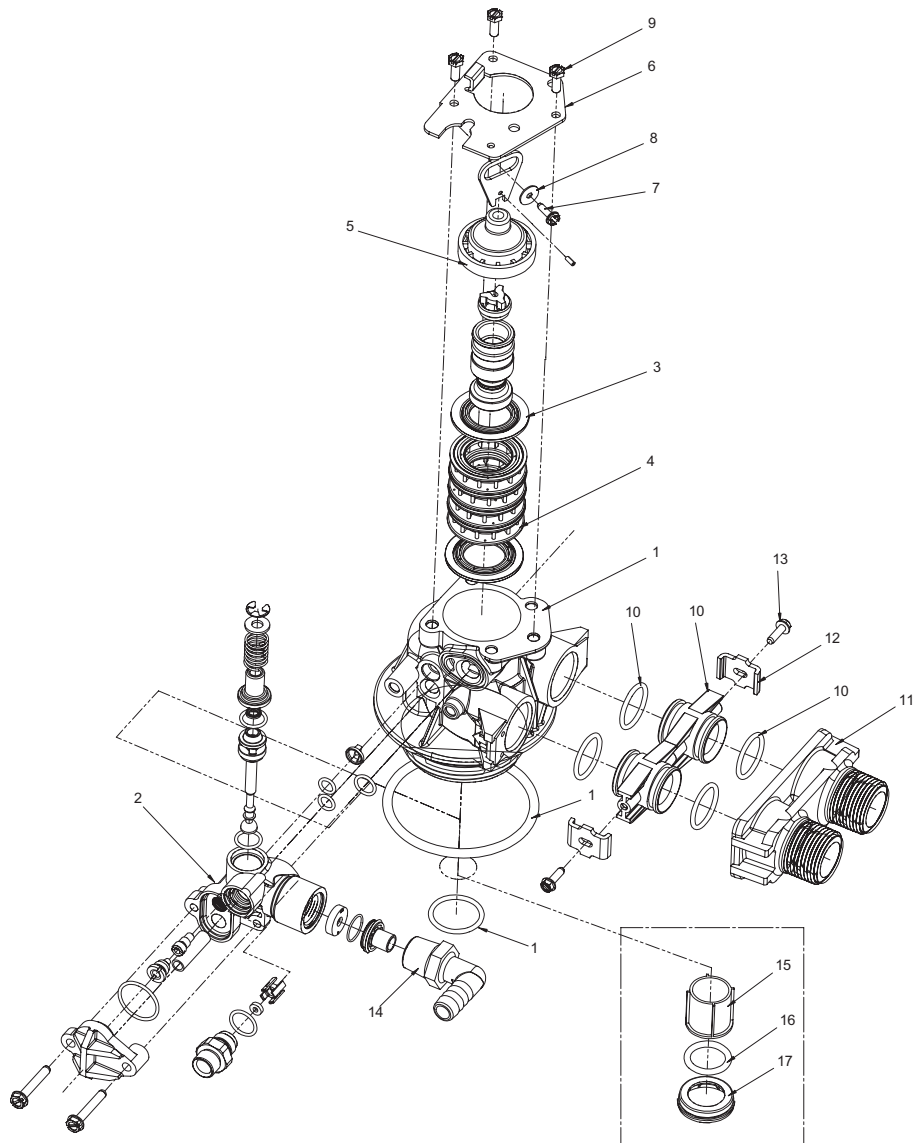

61500-56SE Rev A

CONTROL VALVE ASSEMBLY *CONTINUED*

Item No.	QTY	Part No.	Description	Item No.	QTY	Part No.	Description
1	1	61400-12	Valve Body Assy, 5600, Downflow, w/TOT O-ring	6	1	13546	Retainer, End Plug
	1	19700-10	Valve Body, 5600, Downflow	7	1	13296	Screw, Hex Washer, 6-20 x 1/2
	1	12281	O-ring, -338	8	1	13363	Washer, Plain, .145 ID SS
	1	13304	O-ring, -121	9	3	BR12112	Screw, Slotted Hex Head, #10-24 x .50
2	1	60084-0001	Injector, Drain Assy, 5600	10	2	19228-01	Adapter Assy, Coupling, 5600 w/O-ring
	1	13163	Housing, Injector and Drain		1	19228	Coupling, Adapter
	2	13301	O-ring, 011		2	13305	O-ring, -199
	1	12638	O-ring, 013	11	1	18706	Yoke, 1-inch, NPT, Plastic
	1	10227	Screen, Injector	12	2	13255	Clip, Mounting
	1	10913-1	Nozzle, Injector, #1, Natural	13	2	BR13314	Screw, Hx Washer Head, 8-18 x .60
	1	10914-1	Throat, Injector, #1, White	14	1	12338	Fitting, Elbow, 90 deg.
	1	13166	Cap, Injector, 5600	15	1	13634	Distributor, Pilot, Sleeve
	1	13303	O-ring, -021	16	1	10244	O-ring, -211
	2	13315	Screw, Hx Washer Head, #10-24 x 1-3/16-inch	17	1	13633	Distributor, Pilot Ring, 13/16-inch
	1	15348	O-ring, -563				
	1	13173	Retainer, DLFC Button				
	1	12088	Washer Flow, 2.4 gpm				
	1	13172	Brine Valve Stem				
	1	12626	Seat, Brine Valve				
	1	13167	Spacer, Brine Valve				
	1	13165	Cap, Brine Valve				
	1	11973	Spring, Brine Valve				
	1	11981-01	E-ring				
	1	16098	Washer, Nylon				
	1	12977	O-ring, 015				
	1	13245	Retainer, BLFC				
	1	12095	Washer, Flow Control, .50 gpm				
	1	12550	Quad Ring, -009				
	2	13302	O-ring, -014				
	1	13244	Brine Line Flowcontrol Adapter				
	1	13497	Dispenser, Air, 5600				
	1	13333	Label, Injector, Blank				
	1	BR10760	Label, 1 gpm, 3 lbs. Salt/ min.				
3	5	13242	Seal, 5600				
4	4	14241	Spacer, 5600				
5	1	60102-71	Piston Assy, 6600, Downflow				
	1	17218	Piston, 6600 Downflow				
	1	14309	Retainer, Piston Rod				
	1	13306	Pin, Roll, 3/32 x 1/4				
	1	13003	Link, Piston Rod, 5600				
	1	13243-40	Plug, End, 6600, Green				
	1	13008	Retainer, End Plug Seal				
	1	10209	Quad Ring, -010				

VALVE POWERHEAD ASSEMBLY

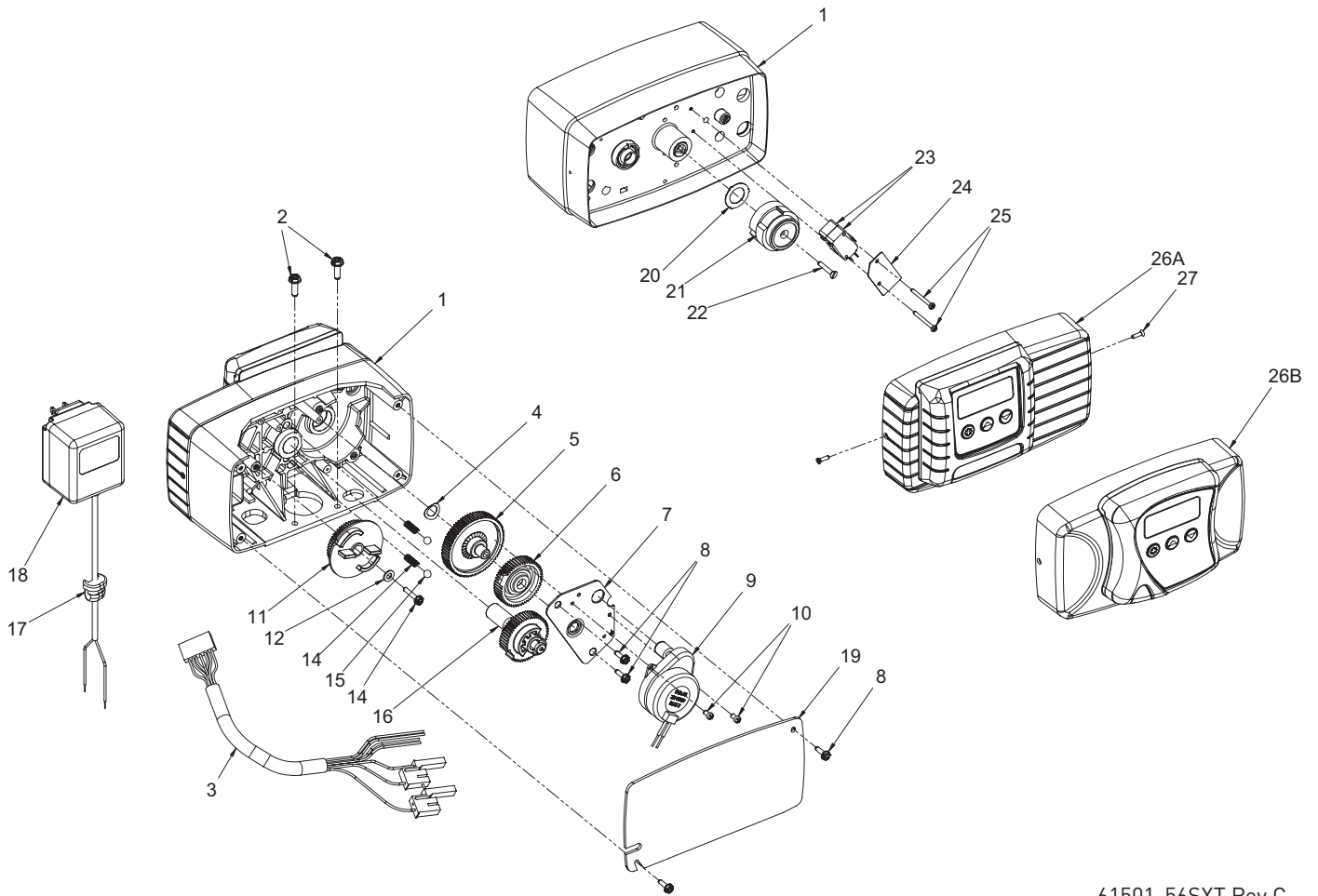

61501-56SXT Rev C

Item No.	QTY	Part No.	Description	Item No.	QTY	Part No.	Description
1	1	14448-100	Drive Housing Assy, with Pin, 56SXT			41475	Transformer, 24V, 9.6VA, European
2	2	12473	Screw, Hex Wsh 10-24 x 5/8	19	1	40338	Cover, Back Drive Housing
3	1	19474	Harness, Power, 56SXT, Elect	20	1	19079	Washer, Friction
4	1	13299	Washer, Spring, 3/8	21	1	17438	Cam, 56SXT/6700, Downflow
5	1	13017	Gear, Idler			40609	Cam, Double Backwash, Downflow
6	1	23045	Gear, Drive, 6700	22	1	15151	Screw, Flat Hd St, 6-20 x 3/4
7	1	13175	Plate, Motor Mounting	23	2	10218	Switch, Micro
8	4	13296	Screw, Hex Wsh, 6-20 x 1/2	24	1	10302	Insulator, Limit Switch
9	1	16944	Motor, Drive, 24V 60 Hz 2 rpm	25	2	17876	Screw, Phil, Pan, 4-40 x 1-1/8
10	2	11384	Screw, Phil, 6-32 x 1/4 Zinc	26A	1	61672-0201	Front Panel Assy, 56SXT, Square, Black
11	1	18722	Cam, Brine Valve, 56SXT/6700 Blk	26B	1	61673-0201	Front Panel Assy, 56SXT, Curved, Black
12	1	12037	Washer, Plain, #10 18-8 Stainless Steel	27	2	13898	Screw, Flat Hd, Phil Steel
13	1	40214	Screw, Hex Wsh, #6-20 x 3/4	Not Shown:			
14	2	19080	Spring, Compression, 6700	4		40422	Wire, Nut, Beige
15	2	13300	Ball, 1/4-inch Stainless Steel	1		60320-03	Switch Kit, 5600, Auxiliary
16	1	42933	Gear, Main Drive, Downflow				
17	1	13547	Strain Relief, Flat Cord				
18	1	44147	Transformer, 24V, 9.6VA, Lvl6				

3/4-INCH TURBINE METER ASSEMBLY

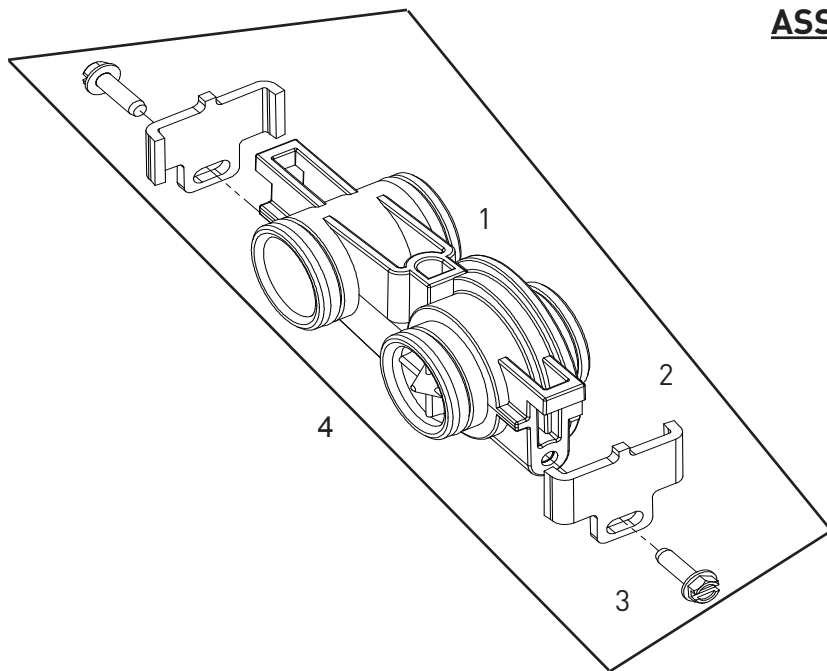

BR60626

Item No.	QTY	Part No.	Description
1	1	19797	Meter Assy, 3/4" Dual Port, SLP
2	2	19569	Clip, Flow Meter
3	2	13314	Screw, Slot Ind Hex, 8-18 x 0.60
4	1	60626	3/4" Turbine, w/Clips & Screws

Not Shown:

.....	14613	Flow Straightener
.....	19121-01	Meter Cable Assy, Turbine/SXT

3/4-INCH PLASTIC PADDLE METER ASSEMBLY

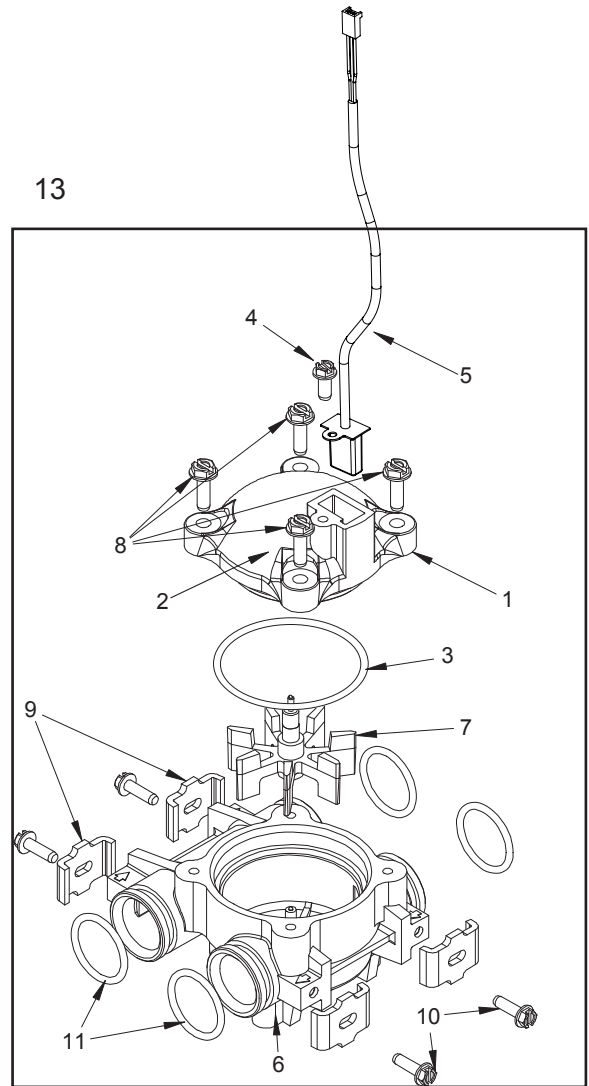

BR60086 Rev E

Item No.	QTY	Part No.	Description
1	1	14716	Meter Cap Assy, NT (includes items 2, 3, and 4)
2	1	13874	Cap, Meter, Electronic
3	1	13847	O-ring, -137, Std, Meter
4	1	17798	Screw, Slot Hex Washer Head
5	1	19121-01	Meter Cable Assy, SXT, Paddle (not included in P/N 60086)
6	1	13821	Body, Meter, 5600
7	1	13509	Impeller, Meter
8	4	12473	Screw, Hex Wsh, 10-24 x 5/8
9	4	13255	Clip, Mounting
10	4	13314	Screw, Slot Ind Hex, 8-18 x 0.60
11	4	13305	O-ring, -119
12	1	14613	Flow Straightener
13	1	60086-50	Meter Assy, 3/4", Elec, Paddlewheel

BYPASS VALVE ASSEMBLY (PLASTIC)

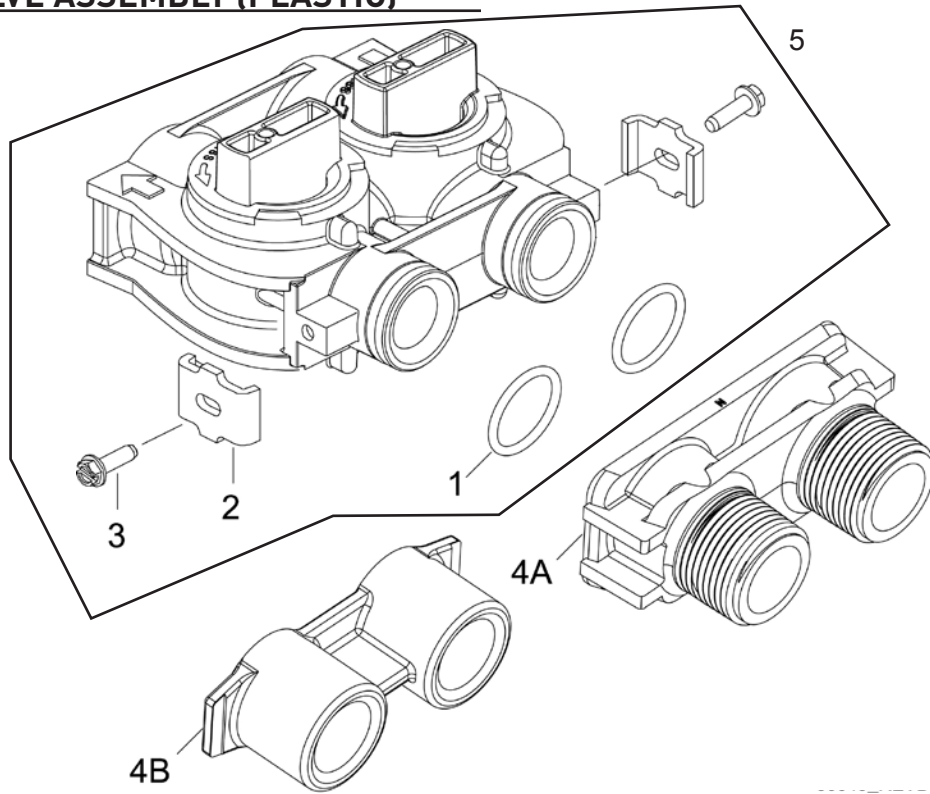

60049 Rev G

Item No.	QTY	Part No.	Description
1	2	13305	O-ring, -119
2	2	13255	Clip, Mounting
3	2	13314	Screw, Hex Washer Head, 8-18 x 5/8
4A	1	18706	1" Yoke, Plastic NPT
		18706-10	1" Yoke, Plastic BSP
		18706-02	3/4" Yoke, Plastic NPT
		18706-12	3/4" Yoke, Plastic BSP
4B	1	61694	1" Yoke, QC
		61700	3/4" Yoke, QC
		13708-40	1" Yoke, Sweat
		41026-01	1" Yoke, SS, NPT
		42690	3/4" Yoke, Sweat
		41027-01	3/4" Yoke, SS, NPT
5	1	60049	3/4" Bypass, Plastic

BYPASS VALVE ASSEMBLY (METAL)

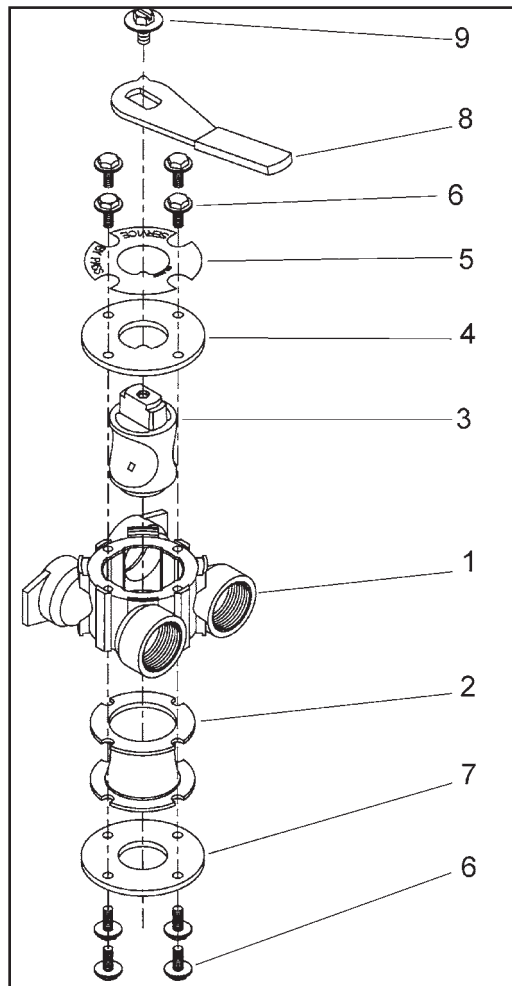

10

60040SS Rev R
60041SS Rev T

Item No.	QTY	Part No.	Description
1	1	17290	Bypass Valve Body, 3/4-inch
		17290NP	Bypass Valve Body, 3/4-inch Nickel Plated
		13399	Bypass Valve Body, 1-inch
		13399NP	Bypass Valve Body, 1-inch, Nickel Plated
2	1	11726	Seal, Bypass
3	1	11972	Plug, Bypass
4	1	11978	Side Cover
5	1	13604-01	Label
6	8	15727	Screw
7	1	11986	Side Cover
8	1	11979	Lever, Bypass
9	1	11989	Screw, Hex Head, 1/4-14
10	1	60040SS	Bypass, 3/4", S.S.
		60041SS	Bypass, 1", S.S.

2300 SAFETY BRINE VALVE

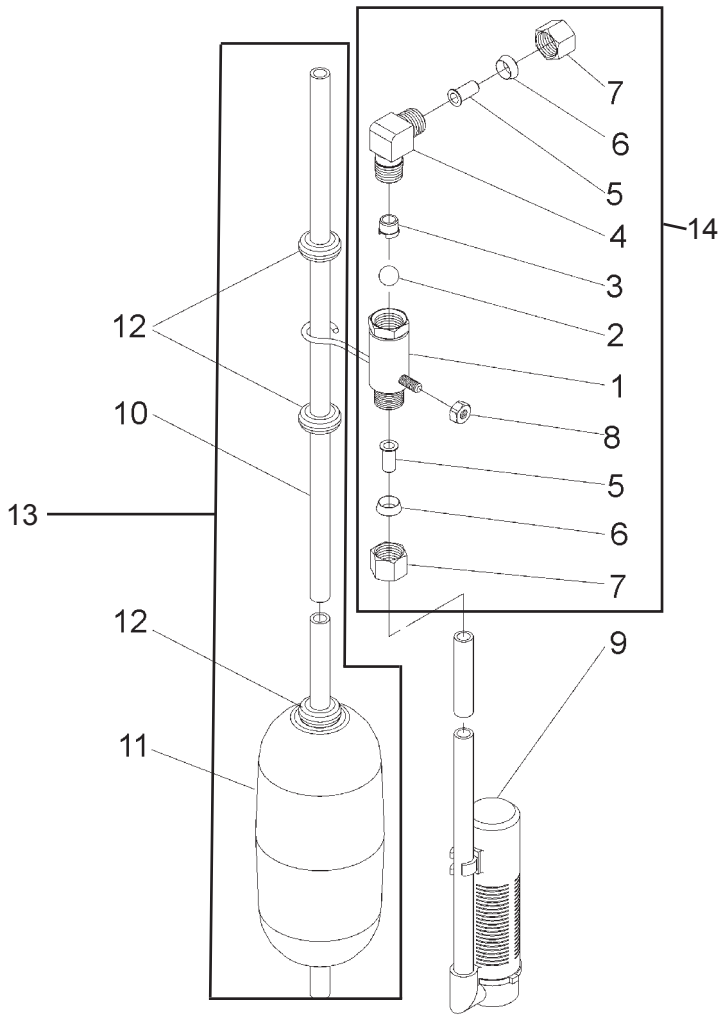

60027 Rev D

Item No.	QTY	Part No.	Description
1	1	11942	Brine Valve Body 1/4-inch NPT
2	1	10138	Ball, 3/8-inch
3	1	11566	Ball Stop
4	1	10328	Elbow, 1/4-inch x 1/4-inch T
5	2	10332	Insert, 3/8-inch
6	2	10330	Sleeve, 3/8-inch
7	2	10329	Tube Nut, 3/8-inch
8	1	10186	Nut, Hex, 10-32, Nylon
9	1	60002-34	Air Check, #500, 34" Long
10	1	10149	Float Rod, 30-inch
11	1	10700	Float Assembly, White
12	4	10150	Grommet
13	1	60028-30	Float Assy, 2300, 30", White
14	1	60027-FFA	Safety Brine Valve, 2300, Fitting Facing Arm
	1	60027-FFS	Safety Brine Valve, 2300, Fitting Facing Stud

2310 SAFETY BRINE VALVE

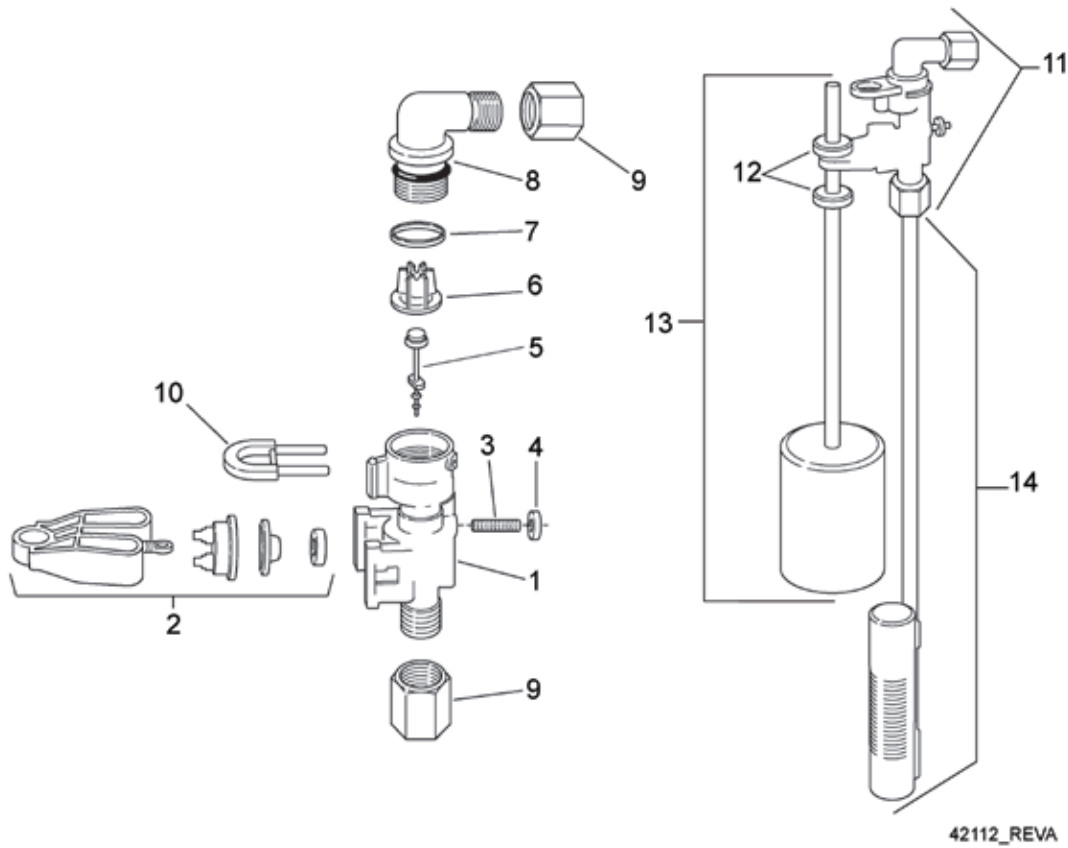

Item No.	QTY	Part No.	Description
1	1	19645	Safety Brine Valve Body
2	1	19803	Safety Brine Valve Arm Assembly
3	1	19804	Stud, 10-24
4	1	19805	Nut, 10-24
5	1	19652-01	Poppet and Seal
6	1	19649	Flow Dispenser
7	1	11183	O-ring, 017
8	1	19647	Elbow, Safety Brine Valve
9	2	19625	Nut Assembly, 3/8
10	1	18312	Retaining Clip
11	1	60014	Safety Brine Valve, 2310 (includes items 1-10)
12	2	10150	Grommet (included with item 13)
13	1	60068-30	Float Assembly, 2310, w/30-inch Rod
14	1	60002-34	Air Check, #500, 34-inch long

TROUBLESHOOTING

Problem	Cause	Correction
Water conditioner fails to regenerate.	Electrical service to unit has been interrupted	Assure permanent electrical service (check fuse, plug, pull chain, or switch)
	Timer is defective.	Replace timer.
	Power failure.	Reset time of day.
Hard water.	By-pass valve is open.	Close by-pass valve.
	No salt is in brine tank.	Add salt to brine tank and maintain salt level above water level.
	Injector screen plugged.	Clean injector screen.
	Insufficient water flowing into brine tank.	Check brine tank fill time and clean brine line flow control if plugged.
	Hot water tank hardness.	Repeated flushings of the hot water tank is required.
	Leak at distributor tube.	Make sure distributor tube is not cracked. Check o-ring and tube pilot.
	Internal valve leak.	Replace seals and spacers and/or piston.
Unit used too much salt.	Improper salt setting.	Check salt usage and salt setting.
	Excessive water in brine tank.	See "Excessive water in brine tank".
Loss of water pressure.	Iron buildup in line to water conditioner.	Clean line to water conditioner.
	Iron buildup in water conditioner.	Clean control and add mineral cleaner to mineral bed. Increase frequency of regeneration.
	Inlet of control plugged due to foreign material broken loose from pipes by recent work done on plumbing system.	Remove piston and clean control.
Loss of mineral through drain line.	Air in water system.	Assure that well system has proper air eliminator control. Check for dry well condition.
	Improperly sized drain line flow control.	Check for proper drain rate.
Iron in conditioned water.	Fouled mineral bed.	Check backwash, brine draw, and brine tank fill. Increase frequency of regeneration. Increase backwash time.
Excessive water in brine tank.	Plugged drain line flow control.	Clean flow control.
	Plugged injector system.	Clean injector and screen.
	Timer not cycling.	Replace timer.
	Foreign material in brine valve.	Replace brine valve seat and clean valve.
	Foreign material in brine line flow control.	Clean brine line flow control.
Softener fails to draw brine.	Drain line flow control is plugged.	Clean drain line flow control.
	Injector is plugged.	Clean injector
	Injector screen plugged.	Clean screen.
	Line pressure is too low.	Increase line pressure to 20 psi
	Internal control leak	Change seals, spacers, and piston assembly.
	Service adapter did not cycle.	Check drive motor and switches.
Control cycles continuously.	Misadjusted, broken, or shorted switch.	Determine if switch or timer is faulty and replace it, or replace complete power head.
Drain flows continuously.	Valve is not programming correctly.	Check timer program and positioning of control. Replace power head assembly if not positioning properly.
	Foreign material in control.	Remove power head assembly and inspect bore. Remove foreign material and check control in various regeneration positions.
	Internal control leak.	Replace seals and piston assembly.

TROUBLESHOOTING *CONTINUED*

Error Codes

NOTE: Error codes appear on the In Service display.

Error Code	Error Type	Cause	Reset and Recovery
0	Cam Sense Error	The valve drive took longer than 6 minutes to advance to the next regeneration position	Unplug the unit and examine the powerhead. Verify that all cam switches are connected to the circuit board and functioning properly. Verify that the motor and drive train components are in good condition and assembled properly. Check the valve and verify that the piston travels freely. Replace/reassemble the various components as necessary. Plug the unit back in and observe its behavior. The unit should cycle to the next valve position and stop. If the error re-occurs, unplug the unit and contact technical support.
1	Cycle Step Error	The control experienced an unexpected cycle input	Unplug the unit and examine the powerhead. Verify that all cam switches are connected to the circuit board and functioning properly. Enter Master Programming mode and verify that the valve type and system type are set correctly with regard to the unit itself. Step the unit through a manual regeneration and verify that it functions correctly. If the error re-occurs unplug the unit and contact technical support.
2	Regen Failure	The system has not regenerated for more than 99 days (or 7 days if the Control Type has been set to Day-of-Week)	Perform a Manual Regeneration to reset the error code. If the system is metered, verify that it is measuring flow by running service water and watching for the flow indicator on the display. If the unit does not measure flow, verify that the meter cable is connected properly and that the meter is functioning properly. Enter a Master Programming Mode and verify that the unit is configured properly. As appropriate for the valve configuration, check that the correct system capacity has been selected, that the day override is set properly, and that meter is identified correctly. If the unit is configured as a Day-of-Week system, verify that at least one day is set ON. Correct the settings as necessary.
3	Memory Error	Control board memory failure	Perform a Master Reset and reconfigure the system via Master Programming Mode. After reconfiguring the system, step the valve through a manual regeneration. If the error re-occurs unplug the unit and contact technical support.
UD	Upper Drive Sync	Power failure install programming change	Valve will automatically recover.

WATER CONDITIONER FLOW DIAGRAMS

Single Backwash Positions Black Cycle Cam (Part Number 17438)	Double Backwash Positions Blue Cycle Cam (Part Number 40609)
Service Position	Service Position
1. Backwash Position	1. First Backwash Position
2. Brine/Slow Rinse Position	2. Brine/Slow Rinse Position
3. Rapid Rinse Position	3. Second Backwash Position
4. Brine Tank Fill Position	4. Rapid Rinse Position
Service Position	5. Brine Tank Fill Position
	Service Position

Service Position

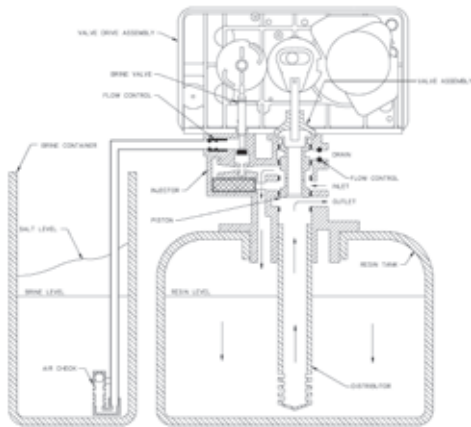

Backwash Position

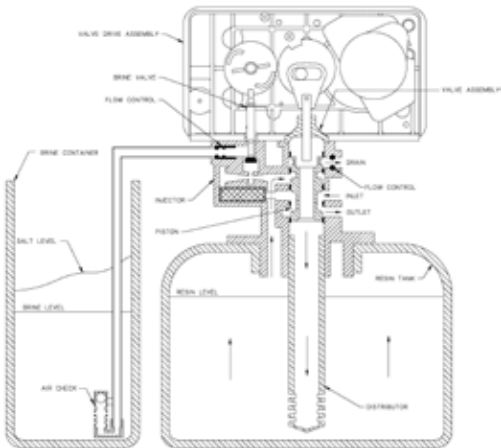

Brine/Slow Rinse Position

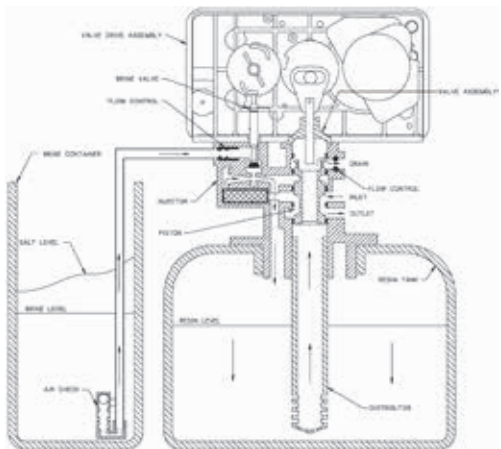

Second Backwash Position (Double Backwash Units Only)

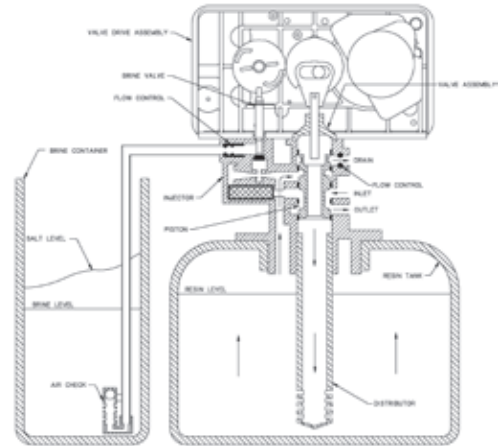

Rapid Rinse

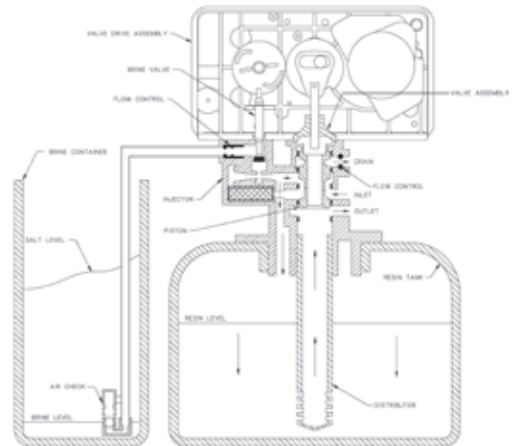

Brine Tank Fill Position

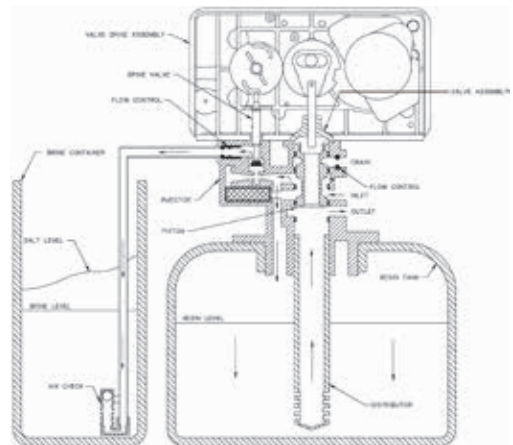

WIRING DIAGRAM

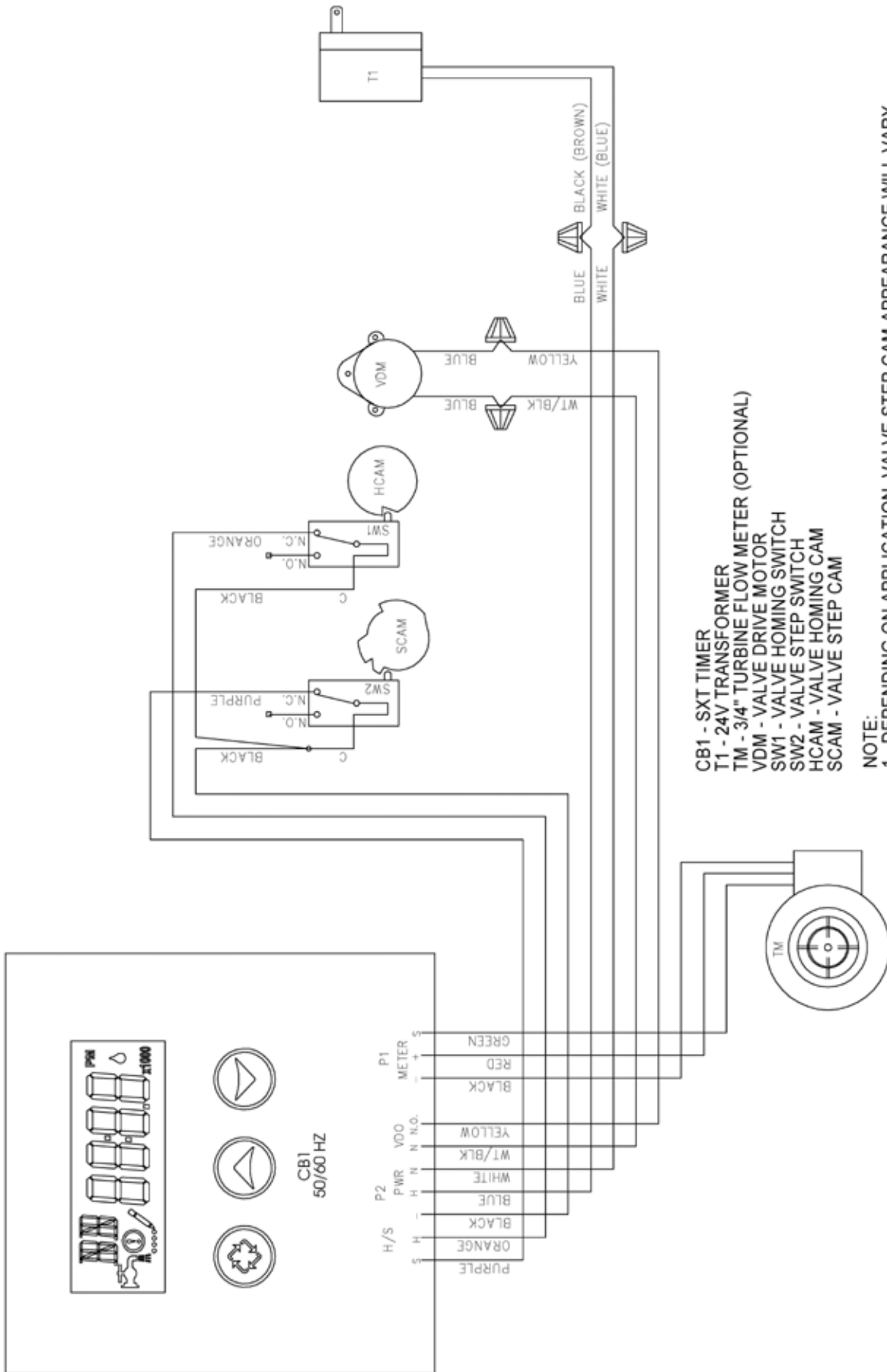

- CB1 - SXT TIMER
- T1 - 24V TRANSFORMER
- TM - 3/4" TURBINE FLOW METER (OPTIONAL)
- VDM - VALVE DRIVE MOTOR
- SW1 - VALVE HOMING SWITCH
- SW2 - VALVE STEP SWITCH
- HCAM - VALVE HOMING CAM
- SCAM - VALVE STEP CAM

NOTE:

1. DEPENDING ON APPLICATION, VALVE STEP CAM APPEARANCE WILL VARY.
2. REGARDLESS OF CAM TYPE USED, WIRING TO SWITCHES SW1 AND SW2 WILL REMAIN AS SHOWN.
3. VALVE SHOWN IN SERVICE POSITION.

SERVICE INSTRUCTIONS

Replacing Brine Valve, Injectors and Screen

1. Turn off water supply to conditioner:
If the conditioner installation has a "three valve" bypass system, first open the valve in the bypass line, then close the valves at the conditioner inlet and outlet.
If the conditioner has an integral bypass valve, put it in the Bypass position.
If there is only a shut-off valve near the conditioner inlet, close it.
2. Relieve water pressure in the conditioner by stepping the control into the Backwash position momentarily. Return the control to the In Service position.
3. Unplug electrical cord from outlet.
4. Disconnect brine tube and drain line connections at the injector body.
5. Remove the two injector body mounting screws. The injector and brine module can now be removed from the control valve. Remove and discard brine body O-rings.

Brine Valve Replacement

1. Pull brine valve from injector body. Also remove and discard o-ring at bottom of brine valve hole.
2. Apply silicone lubricant to new o-ring and reinstall at bottom of brine valve hole.
3. Apply silicone lubricant to o-ring on new valve assembly and press into brine valve hole. Be sure shoulder on bushing is flush with injector body.

Injectors/Screen Replacement

1. Remove injector cap and screen, discard o-ring. Unscrew injector nozzle and throat from injector body.
2. Screw in new injector throat and nozzle, be sure they are sealed tightly. Install a new screen.
3. Apply silicone lubricant to new o-ring and install around oval extension on injector cap.
4. Apply silicone lubricant to three new O-rings and install over three bosses on injector body.
5. Insert screws thorough injector cap and injector. Place this assembly thorough hole in timer housing and into mating holes in the valve body. Tighten screws.
6. Reconnect brine tube and drain line.
7. Return bypass or inlet valve to normal In Service position. Water pressure automatically builds in the conditioner

NOTE: Be sure to shut off any bypass line.

8. Check for leaks at all seal areas. Check drain seal with the control in the Backwash position.
9. Plug electrical cord into outlet.
10. Set Time Of Day and cycle the control valve manually to assure proper function. Make sure control valve is returned to the In Service position.
11. Be sure there is enough salt in the brine tank.
12. Start regeneration cycle manually if water is hard.

Timer Replacement

To replace timer refer to Replacing Brine Valve, Injectors and Screen, steps 1-3.

1. Remove the control valve back cover. Remove the control valve front cover. Disconnect the meter dome signal wire from the front cover and feed it back through the control.
2. Remove screw and washer at drive yoke. Remove timer mounting screws. The entire timer assembly then lifts off easily.
3. Put new timer on top of valve. Be sure drive pin on main gear engages slot in drive yoke.
4. Replace timer mounting screws. Replace screw and washer at drive yoke. Replace meter signal wire.
5. Return bypass or inlet valve to normal In Service position. Water pressure automatically builds in the conditioner.

NOTE: Be sure to shut off any bypass line.

6. Replace the control valve back cover.
7. Follow Injectors/Screen Replacement, steps 9-12.

Piston Assembly Replacement

To replace piston assembly refer to Replacing Brine Valve, Injectors and Screen, steps 1-3.

1. Remove the control valve back cover. Remove the control valve front cover. Disconnect the meter dome signal wire from the front cover and feed it back through the control.
2. Remove screw and washer at drive yoke. Remove timer mounting screws. The entire timer assembly will now lift off easily. Remove end plug retainer plate.
3. Pull upward on end of piston yoke until assembly is out of valve.
4. Inspect the inside of the valve to make sure that all spacers and seals are in place, and that there is no foreign matter that would interfere with the valve operation.
5. Take new piston assembly as furnished and push piston into valve by means of the end plug. Twist yoke carefully in a clockwise direction to properly align it with drive gear. Replace end plug retainer plate.
6. Place timer on top of valve. Be sure drive pin on main gear engages slot in drive yoke.
7. Replace timer mounting screws. Replace screw and washer at drive yoke.
8. Return bypass or inlet valve to normal In Service position. Water pressure automatically builds in the conditioner

NOTE: Be sure to shut off any bypass line.

9. Replace the control valve back cover.
10. Follow Injectors/Screen Replacement, steps 9-12.

SERVICE INSTRUCTIONS *CONTINUED*

Seal and Spacer Replacement

To replace seals and spacers, refer to Replacing Brine Valve, Injectors and Screen, steps 1–3.

1. Remove the control valve back cover. Remove the control valve front cover. Disconnect the meter dome signal wire from the front cover and feed it back through the control.
2. Remove screw and washer at drive yoke. Remove timer mounting screws. The entire timer assembly will now lift off easily. Remove end plug retainer plate.
3. Pull upward on end of piston rod yoke until assembly is out of valve. Remove and replace seals and spacers.
4. Take piston assembly and push piston into valve by means of the end plug. Twist yoke carefully in a clockwise direction to properly align it with drive gear. Replace end plug retainer plate.
5. Place timer on top of valve. Be sure drive pin on main gear engages slot in drive yoke.
6. Replace timer mounting screws. Replace screw and washer at drive yoke.
7. Return bypass or inlet valve to normal In Service position. Water pressure automatically builds in the conditioner.

NOTE: Be sure to shut off any bypass line.

8. Replace the control valve back cover.
9. Follow Injectors/Screen Replacement, steps 9–12.

Meter Replacement

To replace meter refer to Replacing Brine Valve, Injectors and Screen, steps 1–3.

1. Remove two screws and clips at bypass valve or yoke. Pull resin tank away from plumbing connections.
2. Pull meter module out of control valve.
3. Remove signal wire from meter module, (snap tab on end opposite wire cable).
4. Apply silicone lubricant to four new O-rings and assemble to four ports on new meter module.
5. Install signal wire into new meter module.
6. Assemble meter to control valve. Note, meter portion of module must be assembled at valve outlet.
7. Push resin tank back to the plumbing connections and engage meter ports with bypass valve or yoke.
8. Attach two clips and screws at bypass valve or yoke. Be sure clip legs are firmly engaged with lugs.
9. Return bypass or inlet valve to normal In Service position. Water pressure automatically builds in the conditioner.

NOTE: Be sure to shut off any bypass line.

10. Check for leaks at all seal areas.
11. Follow Injectors/Screen Replacement, steps 9–12.

FLOW DATA & INJECTOR DRAW RATES

1600 Injector System w/ 5600 Valve
BRINE DRAW

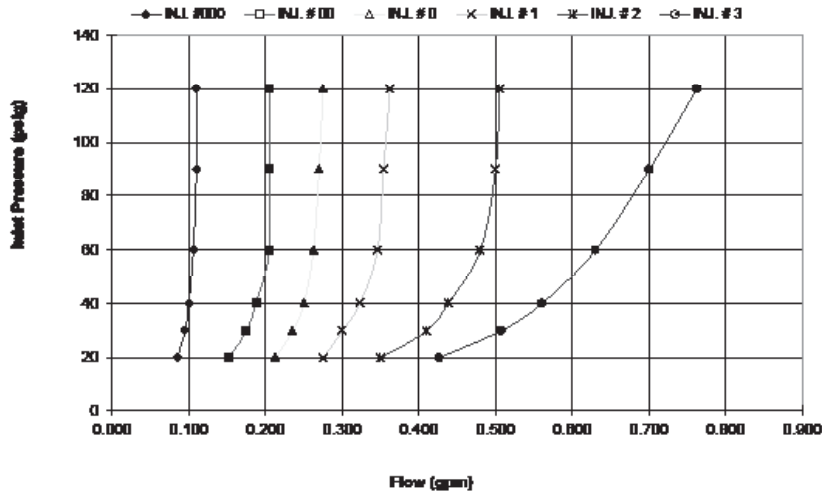

1600 Injector System w/ 5600 Valve
SLOW RINSE

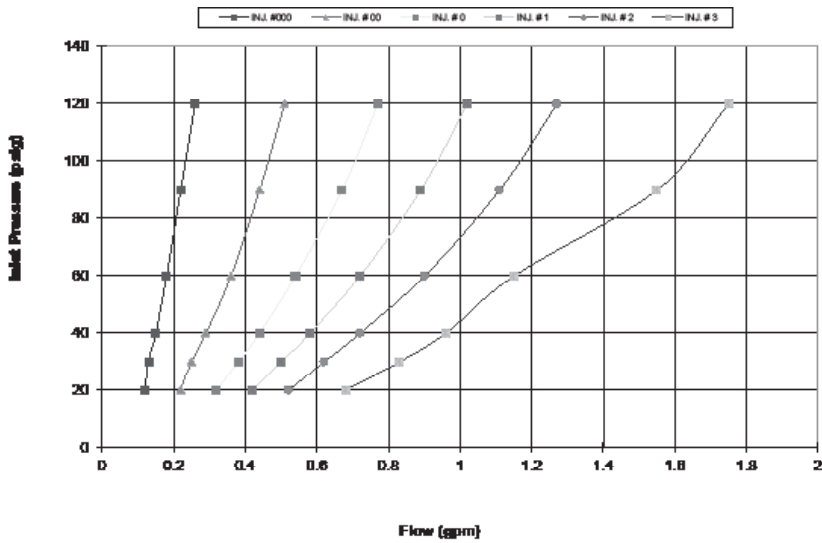

1600 Injector System w/ 5600 Valve
TOTAL FLOW

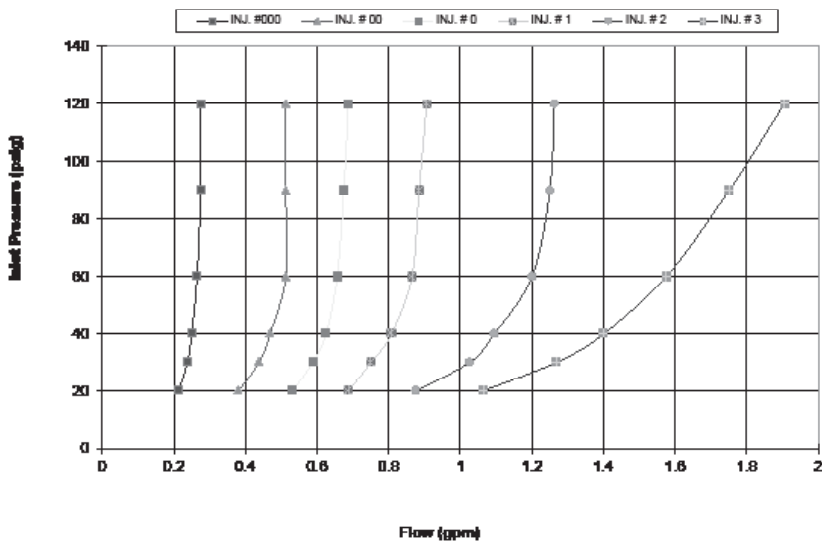

For Fleck Product Warranties visit:
Fleck para las garantías de los productos visite: } [**waterpurification.pentair.com**](http://waterpurification.pentair.com)
Pour Fleck garanties produit visitez le site :



WATER QUALITY SYSTEMS

5730 NORTH GLEN PARK ROAD, MILWAUKEE, WI 53209

P: 262.238.4400 | WATERPURIFICATION.PENTAIR.COM | CUSTOMER CARE: 800.279.9404 | tech-support@pentair.com

[§]For a detailed list of where Pentair trademarks are registered, please visit waterpurification.pentair.com/brands.

Pentair trademarks and logos are owned by Pentair plc or its affiliates. Third party registered and unregistered trademarks and logos are the property of their respective owners.

42684 REV K JL17 © 2017 Pentair Residential Filtration, LLC All Rights Reserved.